

Efficacy of Channel-and-Node Aware Routing Strategies in Wireless Ad Hoc Networks

Jia Liu and A. Annamalai
Mobile & Portable Radio Research Group
Virginia Polytechnic Institute and State University
432 Durham Hall (0350), Blacksburg, VA 24061
Email: {kevinlau, annamalai}@vt.edu

Abstract—Routing protocols for ad hoc networks have generally ignored channel fading and do not exploit the differences in the communication links between nonhomogeneous nodes. We argue that the end-to-end route outage probability (EOP) is a more appropriate metric for abstracting the physical layer performance compared to the conventional minimum hop-count metric, and thus more efficient to minimize packet loss due to fading. The efficacy of three channel-aware routing protocols, and traditional minimum hop count routing strategy are studied analytically based on the EOP metric. Different from the conclusion drawn in [5], we show that the multiple route path selection (MRPS) scheme is inferior to both single route (SR) and multiple route (MR) protocols in many practical MANET scenarios. More importantly, we propose to include node capability information (e.g., remaining battery life/maximum transmit power, diversity receiver etc.) in partial route outage probability calculation to further improve the network performance.

I. INTRODUCTION

Routing is a critical issue in mobile ad hoc networks (MANET) because of their dynamic network topology (mobile station interconnection is achieved via peer level multi-hopping technique) and scarcity in the network resources (bandwidth and battery life). Although routing design is greatly impacted by the fading mechanisms in the wireless channel, existing routing protocols for MANET (see [1] and references therein) consider typically only the path-loss effect as far as propagation impairment is concerned while ignoring the deleterious effects of channel fading and shadowing. Link breakages in wireless networks can severely deteriorate network throughput and routing performance. Another significant impediment of existing routing protocols for wireless ad hoc networks is that the considerable differences in the communication channels between nodes (due to the differences in propagation/interference characteristics and differing capabilities of the heterogeneous nodes themselves) are rarely considered, which can directly impact the network lifetime. For example, some nodes in the network may be equipped with an antenna array while certain other nodes may impose a tight maximum transmit power constraint (due to limited battery life). Route outage probability metric, if used to select optimal route paths, is perhaps more appropriate for MANETs than the conventional minimum hop-count metric because it is much more desirable for a packet to reach its destination with a high success probability even if it involves a few additional hops than it be lost while traversing a route with

fewer hop counts (i.e., the cost of each hop is represented by link outage probability rather than just uniform integer value of “1” for each link used as in conventional routing protocols). An interesting attribute of the “route outage probability” metric is that it allows the abstraction of the physical layer characteristics of the communication link for decisions at higher layers of the protocol stack. Thus one may incorporate the node capabilities (e.g., number of array elements used for diversity combining, remaining battery life) along with the knowledge of the propagation channel using this metric alone.

A. Relation to Previous Studies

Presently there is a serious lack of understanding on how to jointly design and optimize routing protocols that exploits both node capabilities and propagation channel conditions. To the best of our knowledge, no such study has been reported in the literature. Related studies on channel-aware routing protocols, however, have appeared recently [2]–[5]. The “opportunistic” routing protocol that selects a single most reliable route path (in case of source routing - SR) or multiple ordered routes paths (in case of multiple path routing - MR) manifests itself as an order statistics problem. It should be noted that while multiple path routing [8] improves the reliability of packet transmission, this is achieved at the expense of additional network bandwidth because the same information is transmitted over multiple paths. In [2], a multi-route path selection (MRPS) network diversity scheme is introduced. The idea is to forward a packet to the next hop node which has the best channel condition. Modifications to the 802.11 MAC to support MRPS has been discussed in [5]. The MRPS has an advantage over MR scheme because it can effectively mitigate the deleterious effects of channel fading but without requiring additional network bandwidth. Moreover, it is scalable (and therefore preferable over the SR scheme) and its performance is less sensitive to the size of the network.

B. Our Contributions

We extend the analysis presented in [5] in several fronts: (i) perform comparative study between MR-T, SR, MRPS and minimum hop count algorithms in a more general and realistic network topology (that includes node-disjoint topology and m -path n -hop topology as special cases); (ii) develop a unified approach for calculating the end-to-end outage probability (EOP)

over generalized fading channels (including Rice, Nakagami-m, Nakagami-q and Weibull channel models) with nonidentical fading statistics across route paths; (iii) investigate the effects of different maximum transmit power constraint and receiver capability of different nodes on the performance of three channel-aware routing strategies; (iv) develop a recursive algorithm for computing EOP of MRPS scheme for a general network topology; and (v) suggest a simple technique for estimating the fading channel parameters from a finite number of independent sample observations that are required in the partial outage probability calculation at the intermediate nodes. (i.e., how to obtain the channel side information in real-time.)

II. ROUTING SCHEMES BASED ON END-TO-END OUTAGE PROBABILITY

A. Link Outage Probability

In a fading channel, link reliability can be measured using the outage probability metric. The outage probability is the received instantaneous SNR γ falls below a specified threshold γ_{th} . Thus, the outage probability of the j^{th} hop in path i is given by the CDF of γ_{ij} at γ_{th} , namely,

$$P_{o,i}^{(j)} = \Pr\{\gamma_{ij} < \gamma_{th}\} = F_{\gamma_{ij}}(\gamma_{th}), \quad (1)$$

The CDFs of commonly-used channel models, such as Rayleigh, Rice- K , Nakagami- m , Nakagami- q , and Weibull, are summarized in Table I.

Channel Model	CDF of the signal power
Rayleigh	$1 - e^{-\frac{\gamma_{th}}{\bar{\gamma}}}$
Rice- K	$1 - Q\left(\sqrt{2K}, \sqrt{\frac{2(1+K)\gamma_{th}}{\bar{\gamma}}}\right)$
Nakagami- m	$1 - \frac{\Gamma(m, \frac{m\gamma_{th}}{\bar{\gamma}})}{\Gamma(m)}$
Nakagami- q	$\sqrt{1-b^2} \times I_e\left(b, \frac{\gamma_{th}}{(1-b^2)\bar{\gamma}}\right)$
Weibull	$1 - e^{-\frac{\gamma_{th}^c}{\beta}}$

TABLE I

CDF OF SIGNAL POWER OF COMMONLY-USED CHANNEL MODELS.

In Table I, γ_{th} is the threshold value, and $\bar{\gamma}$ is the mean received SNR. For Rice- K fading distribution, $Q(\sqrt{2a}, \sqrt{2b}) = \int_b^\infty e^{-t-a} I_0(2\sqrt{at}) dt$ denotes the first-order Marcum Q-function. For Nakagami- m fading distribution, $\Gamma(a, x) = \int_x^\infty e^{-t} t^{a-1} dt$ is the complementary incomplete Gamma function, m is the Nakagami fading index. The fading parameter q for Nakagami- q is defined as $b = \frac{1-q^2}{1+q^2}$, and Rice's I_e -function is defined as $I_e(k, x) = \int_b^\infty e^{-t} I_0(kt) dt$. For Weibull distribution, the index c is called the Weibull fading parameter and β is a positive scaler. Weibull fading parameter can take values between 0 and ∞ . In the special case when $c = 1$, the Weibull distribution becomes an exponential distribution; when $c = 2$, the Weibull distribution specializes to a Rayleigh distribution.

To determine the fading index in practice, the authors in [6] employed a parametric interference procedure. Fig 1 is adapted from [6] and shows the channel parameter estimation is very

accurate even with only 100 samples. More importantly, this estimation can be done in real-time.

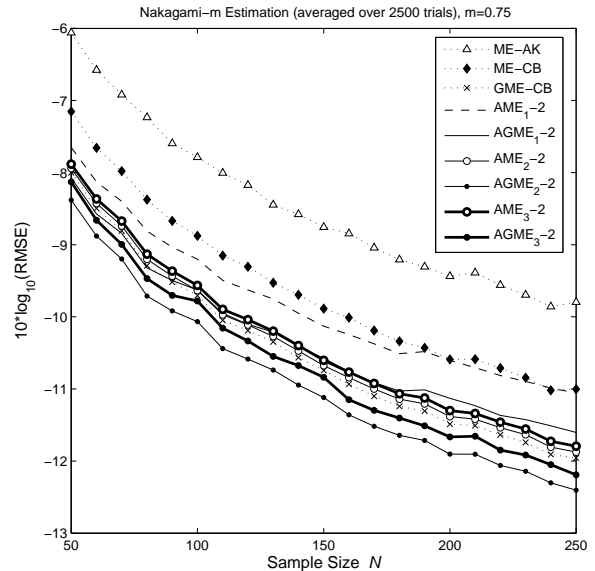

Fig. 1. Channel estimation error with respect to number of samples used.

Once we have the link outage probability, the end-to-end outage probability (EOP) for different routing schemes can be readily computed. To determine the fading index in practice, we may employ a parametric interference procedure as discussed in [6].

B. End-To-End Outage Probability

For path i with n hops, the rate of successfully delivering a packet from source to destination is $\prod_{j=1}^n (1 - P_{o,i}^{(j)})$, where $P_{o,i}^{(j)}$ is the outage probability of the j^{th} link in path i . Hence, the EOP of this path can be computed as

$$\text{EOP}_i = 1 - \prod_{j=1}^n (1 - P_{o,i}^{(j)}), \quad (2)$$

1) *Single Path Routing (SR)*: SR routing scheme chooses the path with the lowest EOP among the N possible paths to the destination. The EOP of SR can be expressed as

$$\text{EOP}_{\text{SR}} = \min_{1 \leq i \leq N} \text{EOP}_i = \text{EOP}_{1:N}. \quad (3)$$

where $\text{EOP}_{k:N}$ denotes the k^{th} order statistics where EOP_i is in ascending order such that $0 \leq \text{EOP}_{1:N} \leq \text{EOP}_{2:N} \leq \dots \leq \text{EOP}_{N:N}$. In practical networks, SR can be simply implemented by modifying a lot of existing ad hoc network routing protocols (such as DSR), using EOP rather than the number of hops as the criterion for choosing an appropriate route to transmit packets.

2) *Multiple Path Routing (MR-T)*: MR-T chooses T routes with the lowest EOP among N possible routes. Therefore, the EOP of MR-T is simply given by

$$EOP_{MR-T} = \prod_{j=1}^T EOP_{j:N}. \quad (4)$$

MR transmits duplicate copies of the same data simultaneously to the destination via multiple paths, thus significantly increasing the reliability. However, the gain in reliability is achieved at the expense of requiring more bandwidth.

3) *Multiple Route Path Selection (MRPS)*: Different to SR or MR-T that the source node chooses the best one or T paths among all possible paths, MRPS operates in a manner where the source and all intermediate nodes examine, if possible, m routes with lowest outage probability in the next hop, and then the packet will be sent to the node that has the best channel condition.

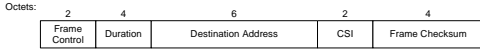

Fig. 2. CTS MAC control frame.

In [5], the authors proposed implementing MAC layer of MRPS by modifying IEEE 802.11 MAC protocol in DCF (Distributed Coordination Function) mode and RTS/CTS mechanism, such that a network node is able to gather the channel state information (CSI) of its neighbors. It is shown in [7] that the best CSI is obtained at the receiver side rather than at the transmitter side. Hence CSI in the MRPS MAC protocol is conveyed in CTS message, which is transmitted from the next-hop candidates back to the transmitter. Fig. 2 shows the modified CTS frame, where a new field “CSI” is added to the packet format. CSI can contain signal-to-noise ratio of the channel or the partial end-to-end outage probability. In order to receive CSI from multiple next-hop candidate nodes, a RTS/CTS protocol that has multicast function is needed. In [11], the authors proposed Batch Mode Multicast MAC (BMMM), which provides reliable multicast function in MAC layer. The authors in [5] further modified it and proposed so-called M-BMMM protocol. The operation of M-BMMM is shown in Fig. 3 with a two next-hop candidates example. The sender S first sends message RTS_1 to node A . Node A replies with message CTS_1 along with the CSI of the link between node S and A . The sender S next sends another message RTS_2 to node B . In BMMM protocol, although node B received CTS_1 from A earlier, it still replies RTS_2 with CTS_2 as long as the source address of RTS_2 and the destination address of CTS_1 are the same. After collecting all CSI information from all next-hop candidate nodes, node S choose one path with the lowest outage probability. Suppose, for example, in Fig. 3 that the path to node B is selected, then node S and node B will exchange RTS/CTS message as usual in IEEE 802.11 DCF. Also notice in Fig. 3 that the duration D_{CTS1} ends at the end of CTS transmission, which allows the neighbor nodes of A communication with A while node S is still sending data to node B .

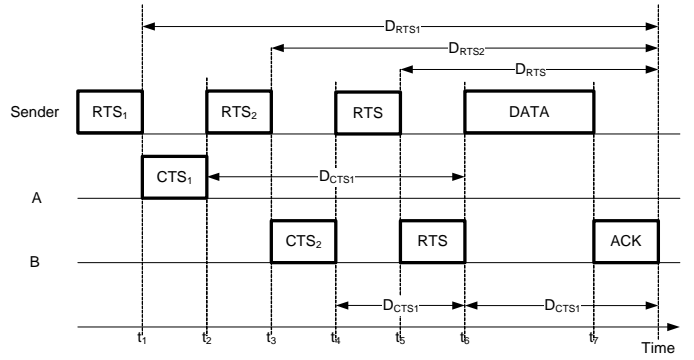

Fig. 3. Time line of M-BMMM protocol (two next-hop candidate nodes).

Generally, it is not straightforward to compute the EOP of MRPS except for some cases with special network topologies and assumptions. In [5], the authors analyzed a N -path n -hop network as shown in Fig. 4, where each node has N multiple paths to the next hop except the nodes at the last hop, and the distance from the source to the destination for all N paths are all n hops. However, this N -path n -hop case considered in [5] is quite unrealistic in a practical networks, since there is no guarantee that each node has exactly N paths to the next hop, and that all paths have exactly the same n hops. Therefore, the authors only analyzed an extreme case for MRPS. Hence, some conclusions drawn in [5] may not be appropriate in general. To shed a light on this, let us examine a simple scenario with node-disjoint topology shown in Fig. 5.

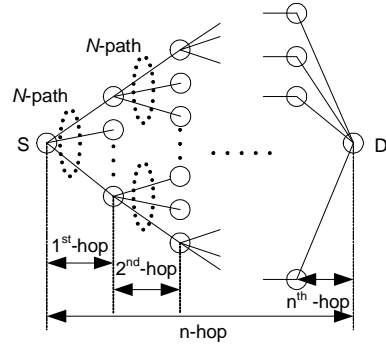

Fig. 4. A m -path n -hop network topology.

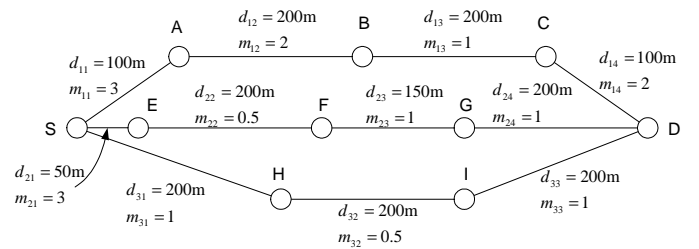

Fig. 5. A 10-node ad hoc network topology

In Fig. 5, the source node S has three paths to reach the destination node D . The total distance of the three paths from

node S to node D are chosen to be the same. Further, we assume that links with different distance experience different fading severity as depicted: m_{ij} corresponds to the Nakagami- m fading index of the j^{th} link of the i^{th} path. We also assume that the path loss exponent $\alpha = 3$, the threshold value of received power is -70dBm , and all network nodes are operating at 2.4GHz frequency band.

For MRPS, the network in Fig. 5 is equivalent to the 3-path 2-hop network shown in Fig. 6. The EOP of MRPS can be calculated by the complementary of the product of successful reception of the 1^{st} and 2^{nd} hop of the equivalent network, i.e.,

$$\begin{aligned} \text{EOP}_{\text{MRPS}} &= 1 - (1 - P_{o,1}^{(1)} \cdot P_{o,2}^{(1)} \cdot P_{o,3}^{(1)}) \times \\ &\quad [(1 - P'_{o,1})P_{\text{SEL}}(1) + (1 - P'_{o,2})P_{\text{SEL}}(2) \\ &\quad + (1 - P'_{o,3})P_{\text{SEL}}(3)], \end{aligned} \quad (5)$$

where $P_{\text{SEL}}(k)$ corresponds to the probability that the k^{th} path is picked. $P_{\text{SEL}}(k)$ can be computed by solving the following equations:

$$\frac{P_{\text{SEL}}(1)}{P_{\text{SEL}}(2)} = \frac{1 - P_{o,1}}{1 - P_{o,2}}; \quad \frac{P_{\text{SEL}}(1)}{P_{\text{SEL}}(3)} = \frac{1 - P_{o,1}}{1 - P_{o,3}} \quad (6)$$

and

$$P_{\text{SEL}}(1) + P_{\text{SEL}}(2) + P_{\text{SEL}}(3) = 1 \quad (7)$$

For example, when the transmit power at each node is 65dBm , solving (6) and (7), we obtain $P_{\text{SEL}}(1) = 0.3336$, $P_{\text{SEL}}(2) = 0.3336$, and $P_{\text{SEL}}(3) = 0.3328$.

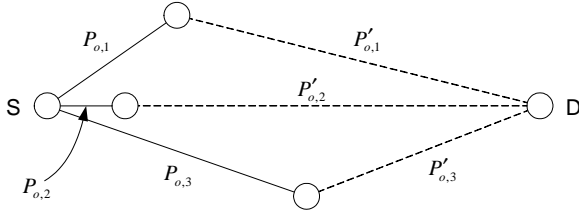

Fig. 6. The equivalent network of Figure 5

In the case of energy efficient multicast and multipath routing in wireless networks, due to the use of omnidirectional antennas, when node i transmits at a power level that could reach a distance r , the transmission is simultaneously received by all nodes that are of a distance less or equal to r from node i . The energy savings that omnidirectional antenna provides is referred in [12] as the Wireless Multicast Advantage (WMA). However, although WMA is desirable in energy saving, it adds more complexity to multicast address management and routing at higher layers.

Fig. 7 depicts the scenario where every node in the network has the same transmit power, not using WMA. It is observed in Fig. 7 that among the three routing schemes, MR-2 has the best performance in terms of link reliability when the transmit power level is between 39dBm and 43dBm . When the transmit power level is greater than 43dBm , MR-3 becomes the most reliable routing scheme. This is because MR-3 has more

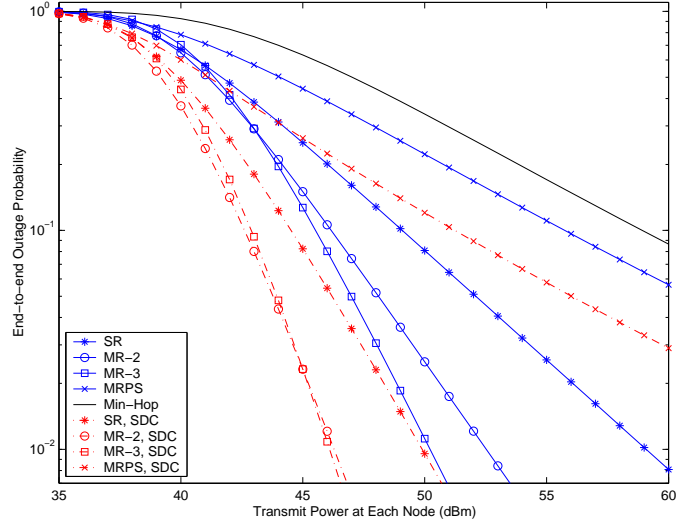

Fig. 7. EOP comparisons of SR, MR-T, MRPS, and Min-Hop routing (same transmit power for every node), without WMA

redundant paths to increase its reliability. For transmit power lower than 39dBm , SR outperforms MR-T because MR-T has to split its transmit power among the links in its first hop, thus having larger outage probability. Notice also that MRPS only performs slightly better than Min-Hop routing in this case.

III. ROUTING SCHEMES EXPLOITING NODE CAPABILITY INFORMATION

A. Energy Constrained Network

In wireless ad hoc network, some nodes are mounted in vehicles and battery life is not a constraint for these nodes. However, the batteries of other nodes may not be rechargeable or even replaceable. Therefore, to extend the lifetime of batteries, different nodes may have different maximum transmit power. To illustrate the effect of considering the different maximum transmit powers of different nodes, we will use the same example in Section II-B again. The network topology and all the fading indexes are remain the same. However, the maximum transmit power of all nodes are different.

In the following example, different maximum transmit power levels are allocated as follows:

$$\begin{bmatrix} 0.398/T & 0.241 & 0.089 & 0.033 \\ 0.398/T & 0.146 & 0.020 & 0.012 \\ 0.398/T & 0.054 & 0.007 & \text{N/A} \end{bmatrix} P_{\text{total}} \quad (8)$$

where each row of this matrix denotes a possible route, and each element of this matrix denotes the maximum transmit power of the according node. Parameter $T = 1$ for SR, Min-Hop, and MRPS routing schemes, and $T = 2$ and $T = 3$ correspond to MR-2 and MR-3 respectively. It is obvious that $\sum_{k=1}^9 P_k = P_{\text{total}}$.

We vary the total transmit power of the 9 transmit nodes from 45dBm to 70dBm , and compare the performance of

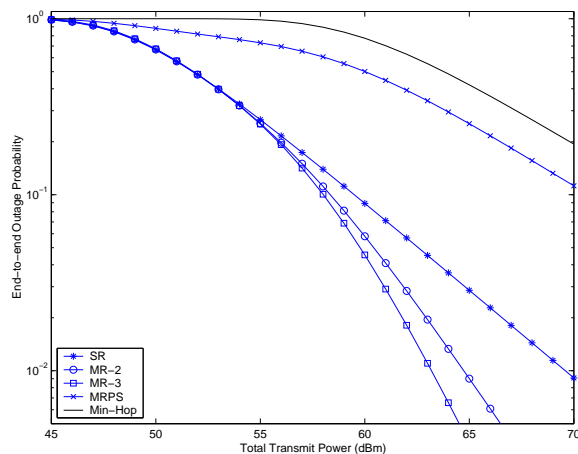

Fig. 8. EOP comparisons of routing schemes with consideration of different maximum transmit powers

SR schemes with and without considering remaining battery energy information. The results are plotted in Fig. 8.

After taking into account the different maximum transmit powers, the performance comparison of different routing schemes still follows the relations in the previous section. However, we can observe that the differences among SR's EOP, MR-2's EOP and MR-3's EOP become smaller now. It shows that after considering the node's capability information of maximum transmit power, we can employ a relatively simple routing scheme, such as SR and MR-2, to achieve a satisfactory routing reliability performance, while saving significant bandwidth than using MR-3.

B. Different Receiver Design

Now let us examine what happens if we take into account the different number of antenna elements. Assume that all nodes with more than one antenna element just simply employ selection diversity combining (SDC) scheme. The outage probability of these more "capable" nodes is given by

$$P'_{out} = (P_{out})^k, \quad (9)$$

where k denotes the number of antenna elements of a node. Again, we use Fig. 5 as an example. Matrix (10) denotes the numbers of antenna elements in this case.

$$\begin{bmatrix} 1 & 1 & 2 & 1 \\ 1 & 4 & 3 & 1 \\ 1 & 1 & 1 & \text{N/A} \end{bmatrix}, \quad (10)$$

where each row of this matrix denotes a possible route, each element of this matrix denotes how many antenna elements the according node has. For example, in route 2 (2^{nd} row), nodes E, F, G, and D have 1, 4, 3, and 1 antenna elements respectively for SDC diversity reception. The performance comparison of difference routing schemes is plotted in Fig. 7.

It is shown in Fig. 7 that the performance difference between MR-2 and MR-3 is quite small. For the total transmit power between 35dBm and 45dBm, the performance of MR-2 is even slightly better than MR-3. This is due to the fact that the

transmit power of MR-3 at the first hop has to be divided by 3, thus reducing the EOP when the transmit power level is low. We also observed in Fig. 7 that SR's performance with consideration of receiver designs is also better than that in Fig. 7 without SDC. Hence it is also concluded that after considering the different nodes' capability information of receiver designs, some relatively simple routing schemes may also achieve satisfactory routing reliability performance.

REFERENCES

- [1] E. M. Royer and C. K. Toh, "A review of current routing protocols for ad hoc mobile wireless networks," *IEEE Personal Comm.*, vol. 6, pp. 46-55, Apr. 1999.
- [2] M. Souryal, B. Vojcic and R. Pickholtz, "Ad Hoc, Multihop CDMA networks with Route Diversity in a Rayleigh Fading Channel," *IEEE MILCOM'01*, vol. 2, 2001.
- [3] R. Zhang and M.S. Alouini, "Channel-Aware Inter-Cluster Routing Protocol for Wireless Ad Hoc networks", *International Symposium on Communication Theory and Applications*, pp. 46-51, July 2001.
- [4] A. Akinyemi and A. Annamalai, "Channel Aware Inter-Cluster Routing Protocol for Wireless Ad-Hoc Networks Exploiting Network Diversity," *Proc. IEEE VTC'2004*, Los Angeles, Sept. 2004.
- [5] M. Park, J. G. Andrews, and S. M. Nettles, "Wireless Channel-Aware Ad Hoc Cross-Layer Protocol with Multi-Route Path Selection Diversity," in *Proc. IEEE Vehicular Technology Conf.*, Fall 2003 vol. 4, pp. 2197-2201, Oct. 2003.
- [6] J. Gaeddert and A. Annamalai, "Further results on Nakagami-m fading parameter estimation," to appear in *IEEE Vehicular Technology Conf.*, Fall 2004.
- [7] G. Holland, N. Vaidya and P. Bahl. "A rate-adaptive MAC protocol for multi-hop wireless networks," In *Proceedings of ACM MOBICOM01*, Rome, Italy, Aug. 2001.
- [8] A. Tsigridis and Z. Haas, "Multiple Path Routing in the Presence of Frequent Topological Changes," *IEEE Commun. Mag.*, pp.132-139, Nov. 2001.
- [9] P. Papadimitratos, Z. J. Haas and E. G. Sirer, "Path set selection in mobile ad hoc networks," In *Proceedings of the ACM Symposium on Mobile Ad Hoc Networking and Computing (MobiHoc)*, Lausanne, Switzerland, June 2002.
- [10] A. Srinivas, E. Modiano, "Minimum Energy Disjoint Path Routing in Wireless Ad-hoc Networks.," In *Proc. ACM MOBICOM03*, Aug. 2001.
- [11] M. Sun, L. Huang, A. Arora and T.H. Lai, Reliable MAC layer multicast in IEEE 802.11 wireless networks, *Proc. IEEE ICPP 2002*, Vancouver, Canada, August 2002.
- [12] J. E. Wieselthier, G. D.Nguyen, and A. Ephremides, "On the Construction of Energy-E.cient Broadcast and Multicast Trees in Wireless Networks," *Proc. IEEE INFOCOM 2000*, Tel Aviv, Isreal, Mar. 2000, pp. 585-94.
- [13] D. Eppstein, "Fiding the k shortest paths," *SIAM J. on Comput.*, vol. 28, no. 2, pp. 652-673, Aug. 1999.
- [14] H. Sherali, K. Ozbay, and S. Subramanian, "The time-dependent shortest pair of disjoint paths problem: Complexity, models, and algorithms," *Networks*, vol. 31, no. 4, pp.259-272, Dec. 1998
- [15] J. Liu, and A. Annamalai, "Comparison of Channel-and-Node Aware Routing Strategies in Wireless Ad Hoc Networks," submitted to *IEEE J. on Wireless Comm.*
- [16] A. Nasipuri and S. R. Das, "On-Demand Multipath Routing for Mobile Ad Hoc Networks," *IEEE ICCCN '99*, PP. 64-70.